

v8 cyclone

User manual

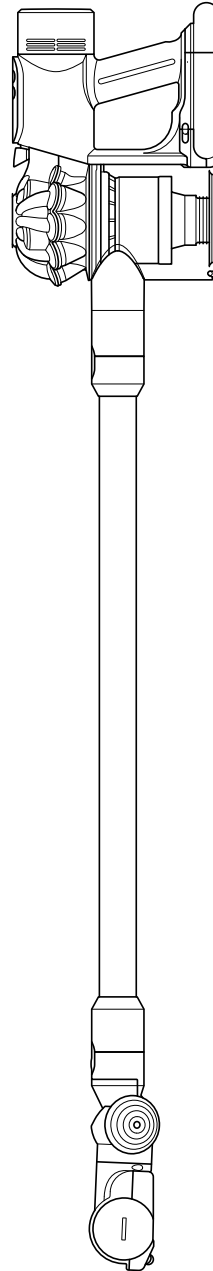

SV12 JN.00000 PN.000000-00-00
00.00.00 VERSION NO.01

Contents

In the box

Caring for your floors

Getting started

Charging your machine

Changing your battery

Emptying your bin

Cleaning your bin

Clearing blockages

Washing the Pre-filter

Washing the Post-filter

Clearing obstructions from your

Motorbar™ cleaner head

Clearing blockages from your

mini motorized tool

Cleaning your tools

Looking after your machine

In the box

Your machine is boxed in 2 parts:

1. Machine body
2. Cleaner head/tools

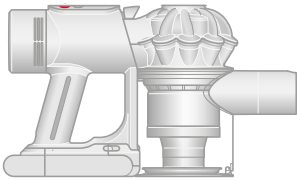

Machine body

Simply attach the cleaner head or tool to the front end of the main body or wand.

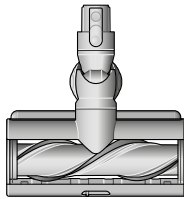

Motorbar cleaner head

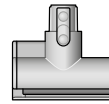

Mini motorized tool

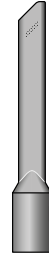

Crevice tool



Wand

The charger can be used independently or as part of the dock.



Charger



Dock

Caring for your floors

Check that the underside of the cleaner head or tool is clean and free from any objects that may cause damage.

Before vacuuming your flooring, rugs, and carpets, check the manufacturer's recommended cleaning instructions.

The brush bar on your cleaner head, or motorized tool, can damage certain flooring. Some rug materials may fuzz if a rotating brush bar is used when vacuuming. If this happens, we recommend vacuuming without the motorized floor tool and consulting with your flooring manufacturer.

Getting started

Operating your machine

There are two easy-to-use buttons on the machine. The top button turns your vacuum on and off, while the lower button changes power mode.

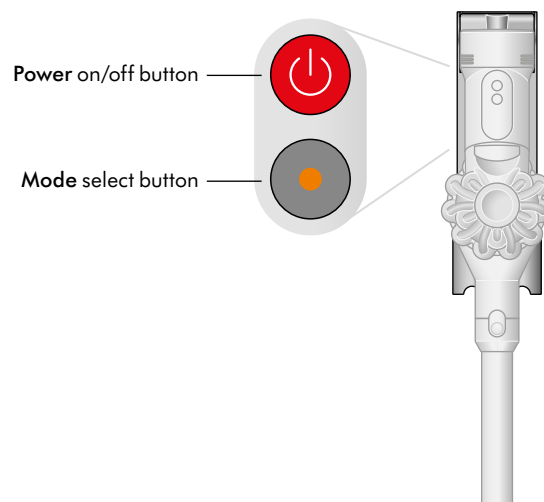

Three power modes

You can cycle between three power modes, depending on floor type and the level of suction needed, using the Mode button.

Eco mode: For longer, lighter cleans

Medium mode: For regular cleaning

Boost mode: For stronger suction



Eco



Med



Boost



Clean awkward spaces

Remove the wand and connect your chosen tool directly to the inlet pipe to use the vacuum as a handheld.

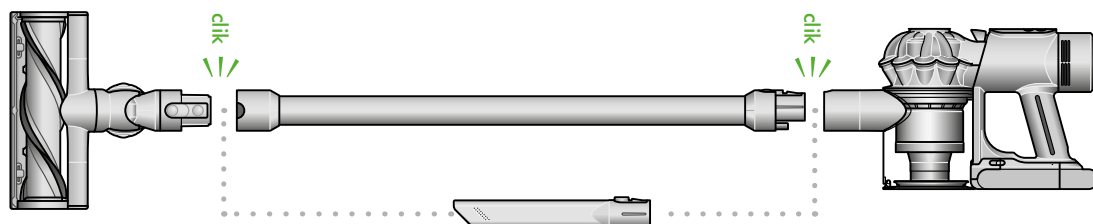



Charging your machine

Fully charge your machine before your first use. Connect to the charger either directly or in the dock.

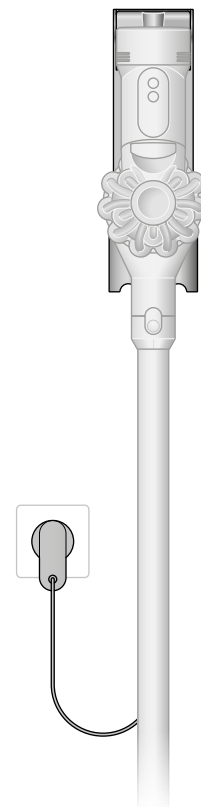





A full charge will take approximately 4 hours. While your battery is charging, the LED will flash to demonstrate the level of charge. Once your machine is fully charged, the light will turn off.



Battery LED

	Pulsing blue	Machine is charging
	No light	Machine is fully charged
	Flashing blue	Battery fault

Machine LED (Mode button)

	Solid blue, green or red	Normal operation
	Flashing blue, green or red	Battery low
	No light	Battery empty
	Solid orange light	Motor fault
	Flashing orange light	Incompatible tool
	Flashing white light	Cyclone not fitted correctly

Changing your battery

Push the Battery release button on the handle and slide the battery off your machine. Align your second battery with the handle and slide it in. Push firmly until it clicks into place.

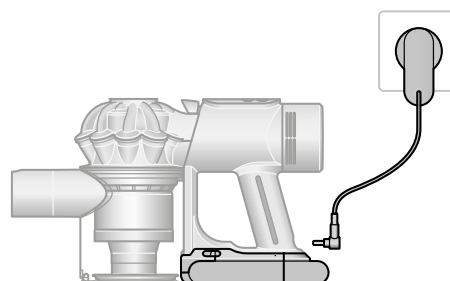

Emptying your bin

Empty as soon as the dirt reaches the top level – don't overfill. Using your machine when the dirt is above the top line may affect the performance and require more frequent filter washing.

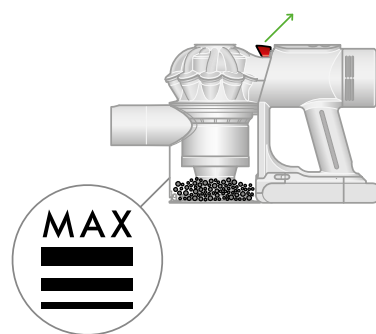

Release the dirt

Remove the wand from your machine.

Hold your machine over a bin and pull the bin release catch upwards. The cyclone will slide up and the bin base will open.

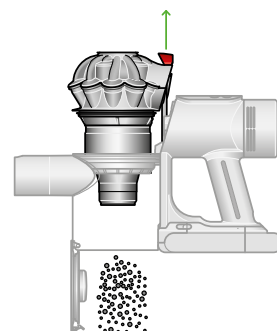

Minimize dust contact

Cover your bin tightly in a dust-proof bag while you empty. Remove the bin carefully, seal the bag tightly and dispose.

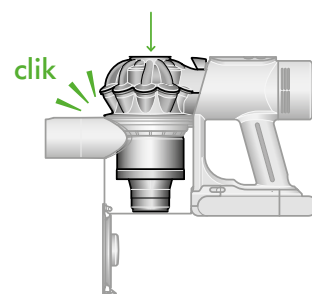

Close the bin

Push down on the cyclone until it slides into position. Push the bin base upwards until it closes securely.

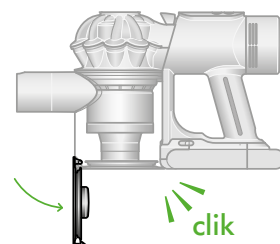

Cleaning your bin

Empty your bin as soon as the dirt reaches the top mark.

You may need to clean the filter more often if you use your machine with a full bin.

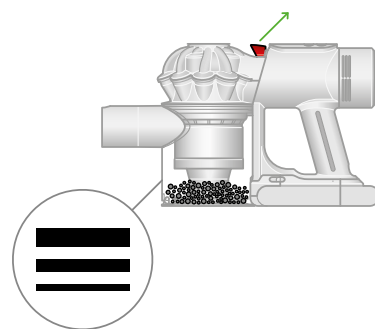

Empty your bin

Remove the wand from your machine.

Hold your machine over a bin and pull the bin release catch upwards. The cyclone will slide up and the bin base will open.

Remove the cyclone

Pull the bin release catch upwards. The cyclone will slide up and the bin base will open.

Locate the cyclone release button behind the cyclone and push to remove the cyclone from your machine.

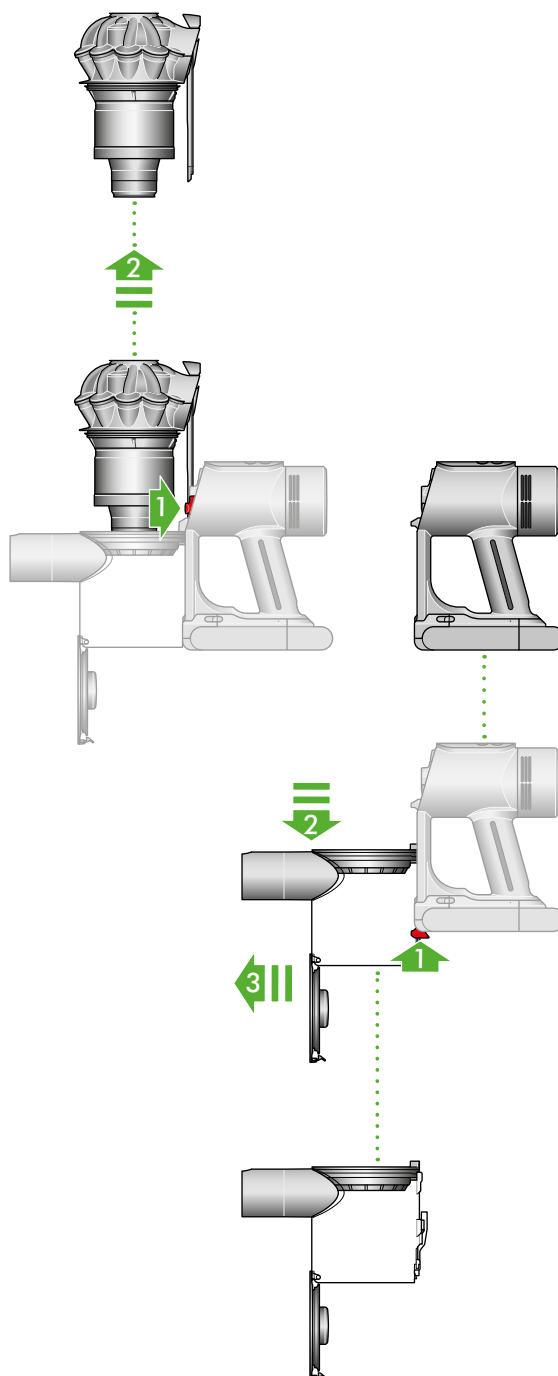

Remove the bin

Pull back on the red catch located on the base, slide the bin down and pull it off your machine.

Clean the bin

Wipe your bin with a damp, lint-free cloth. Don't put the bin in a dishwasher or use detergents, polishes or air fresheners.

Make sure the bin is completely dry before replacing.

Replace the bin

Align the tabs on the bin with the grooves on the main body and slide it upwards until it clicks into place.

Replace the cyclone

Slide the cyclone into the grooves of the main body and push down until it is in position.

Push the bin base up until it clicks firmly shut.

Clearing blockages

Your machine is fitted with an automatic cut-out. If any part of it is blocked, your machine's motor will pulse and won't function until the blockage has been cleared.

Disconnect your machine from the charger before looking for blockages. Be careful not to touch the trigger and be aware of sharp objects.

Leave your machine to cool down before looking for blockages.

Don't use your machine when looking for blockages as this could cause injury.

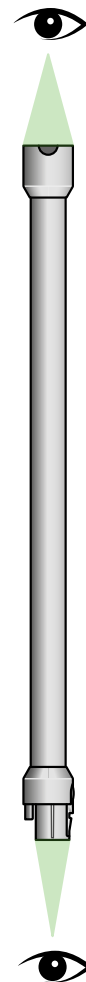
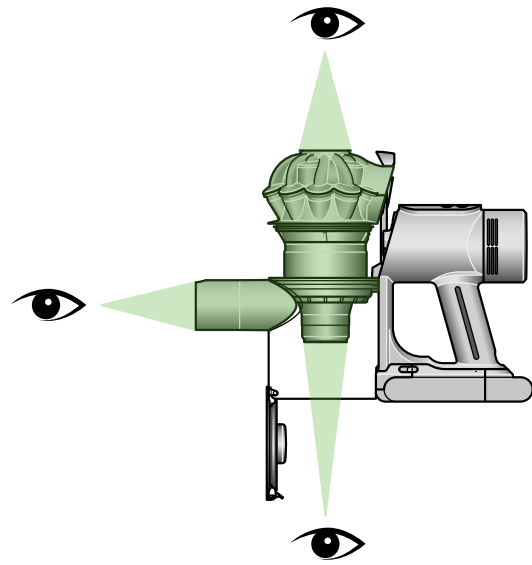

Washing the Pre-filter

Remove your filter

Lift the filter out of the top of the cyclone.

Tap to remove excess dust and debris.

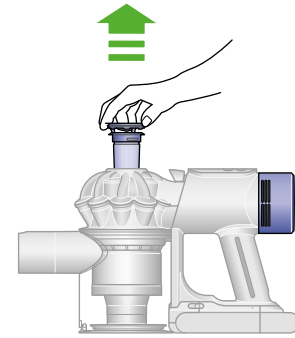

Wash your filter

Hold the open end of the filter under a running tap, until the water runs clear.

Turn the filter upside down and tap it to remove excess water.

Run water over the outside of the filter until the water runs clear.

Squeeze and twist with both hands to make sure the excess water is removed.

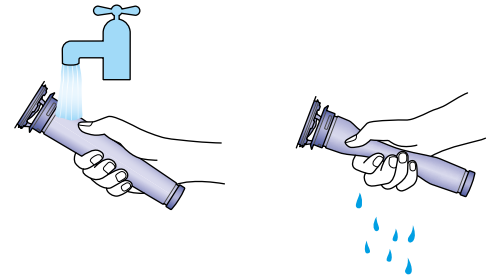

Dry your filter

Leave your filter to dry for at least 24 hours in a well-ventilated, warm place.

Do not dry your filter in a tumble-dryer or near a naked flame.

Important: your filter must be completely dry before you put it back into the machine. Your machine could be damaged if used with a damp filter.

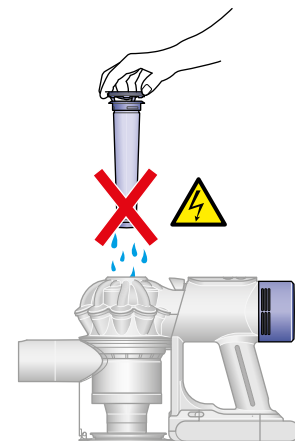
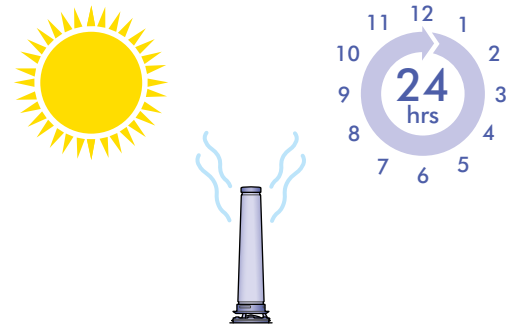

Refit your filter

Align the arrow on the top of the filter with the bin release button.

Push down to fit securely in place.

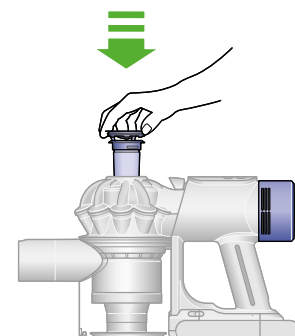

Washing the Post-filter

Twist off your filter

Twist your filter anti-clockwise and pull it away from your machine.

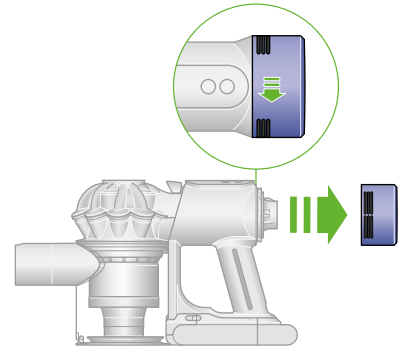

Wash your filter

Wash the inside of the filter under cold, running water, rotating the filter to make sure all of the inside is clean.

Repeat until the water runs clear.

Shake out the water

Empty the filter and shake firmly to remove excess water.

Keep shaking it until there's no water coming from the filter.

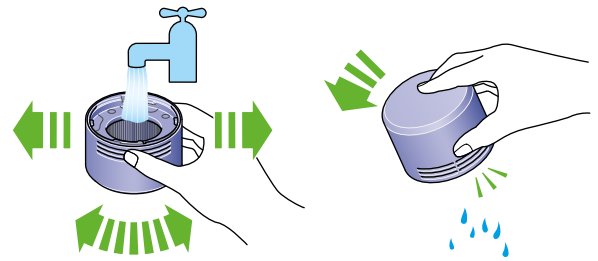

Dry your filter

Place your filter, with the open end facing up, to dry.

Leave your filter to dry for at least 24 hours in a well-ventilated, warm place.

Do not dry your filter in a tumble-dryer or near a naked flame.

Important: your filter must be completely dry before you put it back into the machine. Your machine could be damaged if used with a damp filter.

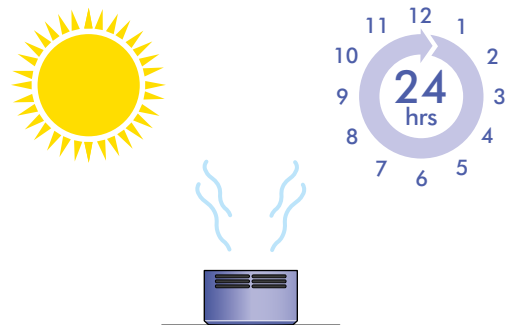

Replace your filter

Place your filter on your machine, aligned in the open position.

Twist clockwise until it clicks securely into position.

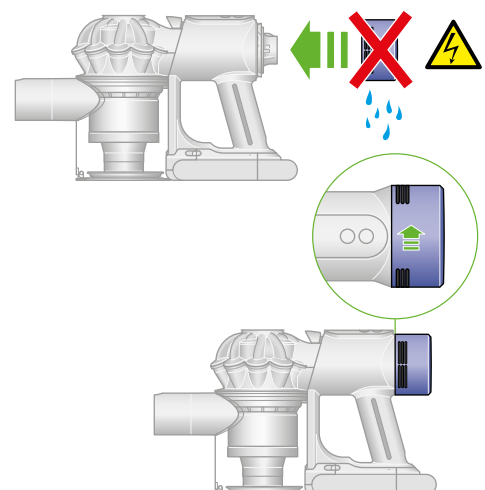

Clearing obstructions from your Motorbar™ cleaner head

Your Motorbar™ cleaner head doesn't have a washable brush bar. To maintain optimum performance, check your brush bar regularly and clear any obstructions.

Make sure your machine is disconnected from the charger and take care not to touch the power button.



Remove your brush bar

Don't put any part of your machine in a dishwasher or use detergents, polishers or air fresheners.

Press the cleaner head release button on the end of the wand. Place the cleaner head upside down.

Use a coin to unlock the end cap.

Twist the end cap and remove it from your brush bar. Don't wash the end cap.

Slide your brush bar out of the cleaner head.

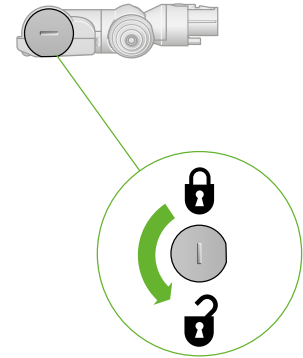

Look for obstructions

Clear any debris from your brush bar.

Check inside the cleaner head and remove any debris or blockages.

Your Motorbar™ cleaner head and brush bar aren't washable. Wipe over with a damp lint-free cloth.

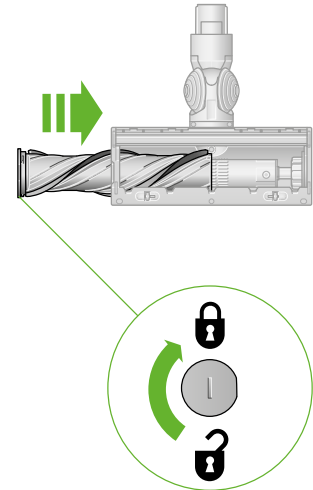

Replace your brush bar

Push the end cap back on to your brush bar and slide it back into the cleaner head.

Turn the end cap clockwise into the locked position.

Your cleaner head isn't washable and should only be wiped over with a damp lint-free cloth.

Clearing blockages from your Mini motorized tool

Your Mini motorized tool doesn't have a washable brush bar. To maintain optimum performance, check your brush bar regularly and clear any obstructions.

Make sure your machine is disconnected from the charger and take care not to touch the power button.

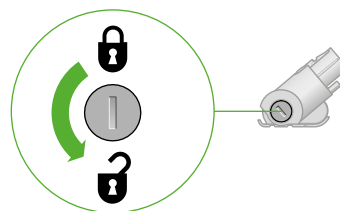

Remove the brush bar

Don't put any part of your machine in a dishwasher or use detergents, polishers or air fresheners.

Use a coin to unlock the end cap.

Twist the end cap and remove it from your brush bar. Don't wash the end cap.

Slide your brush bar out of the cleaner head.

Look for obstructions

Clear any debris from your brush bar.

Check inside the cleaner head and remove any debris or blockages.

Your Mini motorized tool and brush bar aren't washable. Wipe over with a damp lint-free cloth.

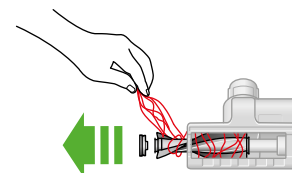

Replace your brush bar

Push the end cap back on to your brush bar and slide it back into the cleaner head.

Turn the end cap clockwise into the locked position.

Your cleaner head isn't washable and should only be wiped over with a damp lint-free cloth.

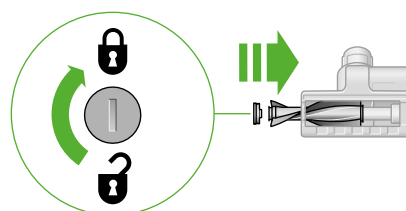

Cleaning your tools

Don't put any part of your machine in a dishwasher or use detergents, polishes or air fresheners.

Wipe with a damp, lint-free cloth, without touching the connector end.

Make sure your tools are completely dry before using.

Crevice tool

Do not wash any cleaner head or motorized tool. They contain electronic components that could be compromised by exposure to water, detergents, polishes or air fresheners.



Crevice tool

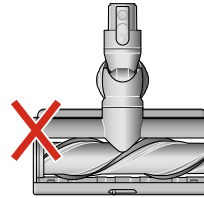

Motorbar™ cleaner head

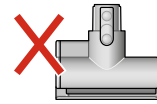

Mini motorized tool

Looking after your machine

To always get the best performance from your machine, it's important to clean it regularly and check for blockages.

Day-to-day machine care

To get the best performance from your machine, it's important to clean it regularly.

If your machine is dusty, wipe with a damp lint-free cloth.

Look after your battery

For best performance and battery life, only use MAX mode when needed.

Your battery is designed to charge on the dock and stops charging when complete, so returning the machine to the dock after use helps to maintain battery life.

Your machine won't operate or charge if the ambient temperature is below 5°C (41°F). This is designed to protect both the motor and battery.

Where to find your machine's serial number

The serial number is printed on the main body of the machine, behind the back of the clear bin.

Use the serial number to register your machine.

For more information and support videos for your machine, go online: www.dysoncanada/support