

v10 konical

User manual

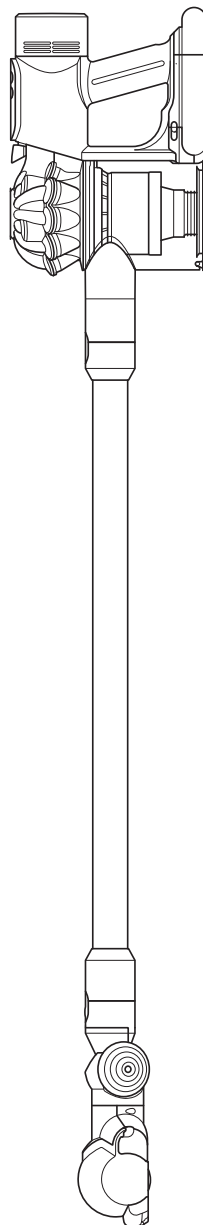

SV12 JN.00000 PN.000000-00-00
00.00.00 WEST VERSION NO.01

Contents

In the box

Getting started Dyson V10 Konical™ vacuum

Getting started Auto-empty Dok™

Charging your vacuum with
Auto-empty Dok™

Changing your click-in battery

Charging your machine with the Wall Dok™

Caring for your floors

Emptying your bin with Auto-empty Dok™

Emptying your bin

Changing the bin on your vacuum

Clearing blockages from your vacuum

Washing the Pre-filter

Washing the Post-filter

Clearing obstructions from your

De-tangling conical head

Clearing blockages from your

Mini motorized tool

Cleaning your tools

Changing your Auto-empty Dok™ liner

Washing the filter of your Auto-empty Dok™

Re-purchasing dust liners for your

Auto-empty Dok™

Looking after your machine

dyson

In the box

Your machine is boxed in 2 parts:

1. Machine body
2. Cleaner head/tools

Main body showing the handle and bin attached

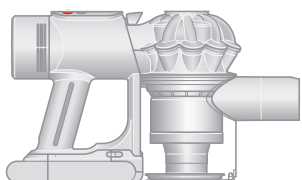

Machine body

Simply attach the cleaner head or tool to the front end of the main body or wand.

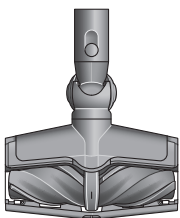

De-tangling conical head

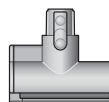

Mini motorized tool

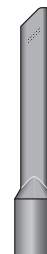

Crevice tool



Wand

The charger can be used independently or as part of the dock.

Please note, these are not included when purchased with Auto-empty Dok™.



Charger



The Wall Dok™

When purchased with Auto-empty Dok™:



Auto-empty Dok™ body

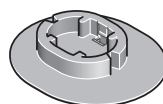

Auto-empty Dok™ base



Auto-empty Dok™ liners

Getting started

Dyson V10 Konical™ vacuum

Operating your machine

There are two easy-to-use buttons on the machine. The top button turns your vacuum on and off, while the lower button changes power mode.

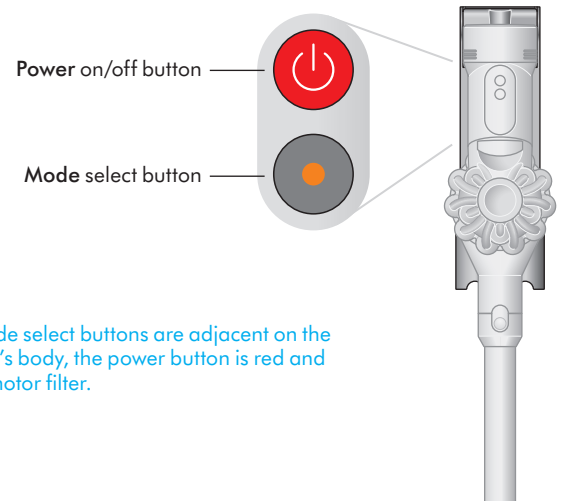

The Power and Mode select buttons are adjacent on the top of your vacuum's body, the power button is red and closer to the post-motor filter.

Three power modes

You can cycle between three power modes, depending on floor type and the level of suction needed, using the Mode button.

Eco mode: For longer, lighter cleans

Medium mode: For regular cleaning

Max mode: For stronger suction



Eco



The Eco icon, a tall green battery



Med



The Med icon, a medium-size blue battery



MAX



The Max icon, a short red battery

Clean awkward spaces

Remove the wand and connect your chosen tool directly to the inlet pipe to use the vacuum as a handheld.



Tools and cleaner heads can be attached either to the wand or directly to the main body of your vacuum. If using the wand, it must also be connected to the main body of your vacuum.

Getting started Auto-empty Dok™

Place the body of the dock onto the base plate.

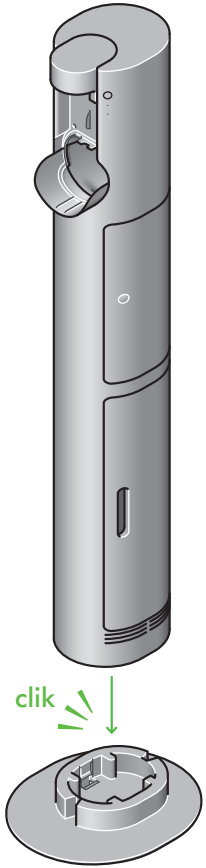

Plug the dock in a socket, ready for use with your vacuum.

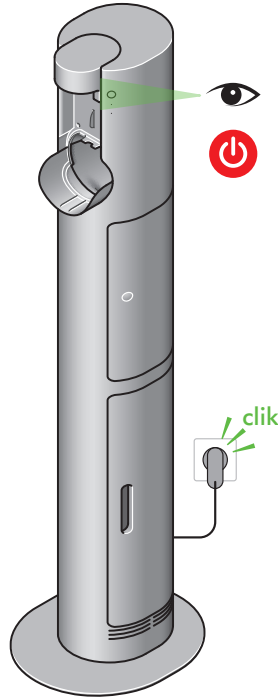

Tilt your vacuum forwards and move upward to click into place.

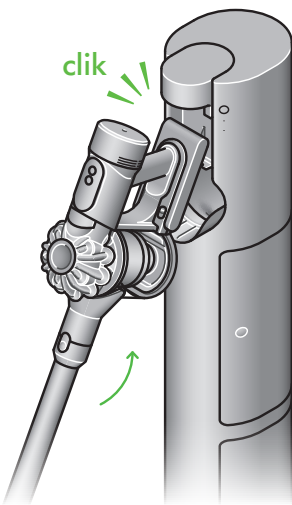

Look for the indicator light to check the machine is charging

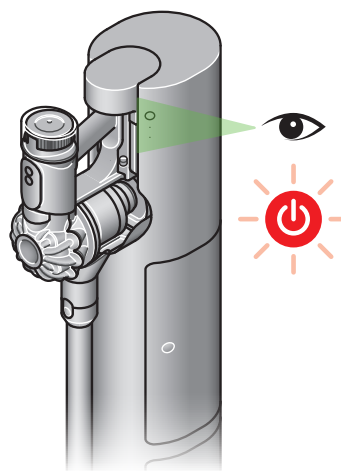

Charging your vacuum with Auto-empty Dok™

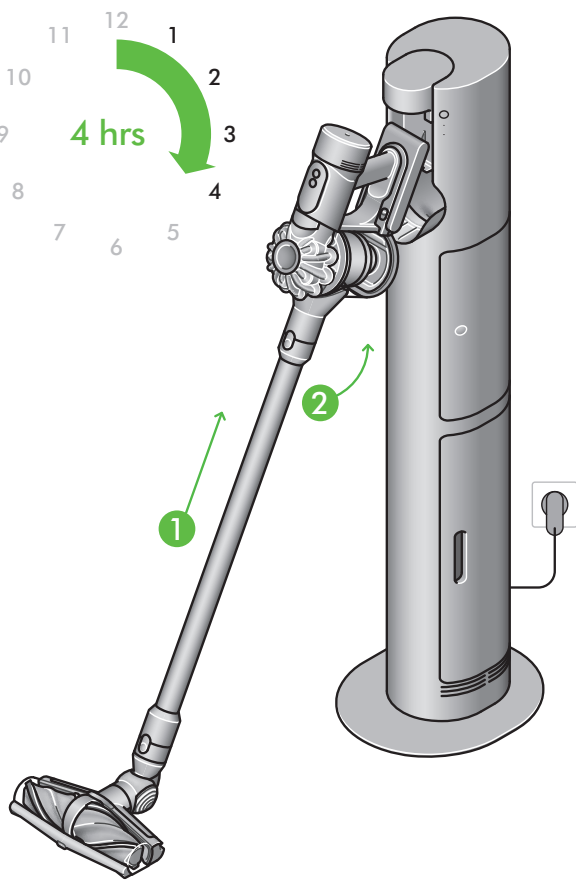

If you have an Auto-empty Dok™, place the vacuum in the dock. Allow up to four hours to ensure the vacuum cleaner fully charges before the first use.

Changing your click-in battery

If you have additional click-in batteries, we recommend that you alternate the batteries to maintain even performance.

Removing your battery

Push the Battery release button on the handle and slide the battery off your machine.

Charge the battery.

Refitting your battery

Align your second battery with the handle and slide it in. Push firmly until it clicks into place.

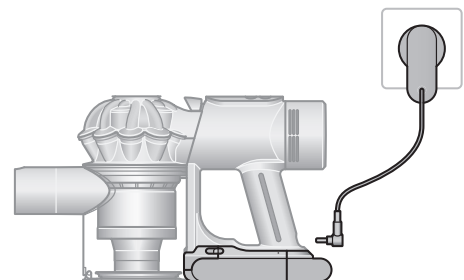



The battery is mounted below the handle of your vacuum

Charging your machine with the Wall Dok™







Allow up to four hours to fully charge your machine before your first use. While your battery is charging, the LED will flash to demonstrate the level of charge. Once your machine is fully charged, the light will turn off.



Battery LED

	Pulsing blue	Machine is charging
	No light	Machine is fully charged
	Flashing blue	Battery fault

Machine LED (Mode button)

	Solid blue, green or red	Normal operation
	Flashing blue, green or red	Battery low
	No light	Battery empty
	Solid orange light	Motor fault
	Flashing orange light	Incompatible tool
	Flashing white light	Cyclone not fitted correctly

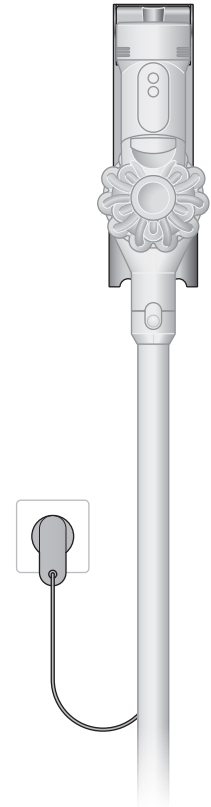

Caring for your floors

Check that the underside of the cleaner head or tool is clean and free from any objects that may cause damage.

Before vacuuming your flooring, rugs and carpets, check the manufacturer's recommended cleaning instructions.

The brush bar on your cleaner head, or mini motorized tool, can damage certain flooring. Some rug materials may fuzz if a rotating brush bar is used when vacuuming. If this happens, we recommend vacuuming without the motorized floor tool and consulting with your flooring manufacturer.

Emptying your bin with Auto-empty Dok™

Simplify bin emptying by inserting your vacuum into the dock until you hear a click and see the light on the dock with a pulsing white light. It should automatically start the auto-empty cycle.

In case you need to run it again, press the red button on the dock.

Indicators on the dock

1. Emptying cycle is indicated by a white pulsing light.
2. Full dust liner is indicated by a solid orange light (not pulsing).

If the liner is missing or not inserted correctly the orange pulsing light will begin. Either insert a new liner or remove and re-insert the original. Once corrected, the light will turn off.

3. Blockages are indicated by a solid orange light. This means self-emptying is impacted.

Dust liner LED indicator

	Solid orange light	Dust liner is full
	Pulsing orange light	Dust liner is missing

Blockage LED indicator

	Solid orange light	When filter or system blockage is detected
--	---------------------------	--

Emptying your bin

Empty as soon as the dirt reaches the MAX level – don't overfill. Using your machine when the dirt is above the top line may affect the performance and require more frequent filter washing. The bin release button is next to the cyclones on the top of your vacuum.

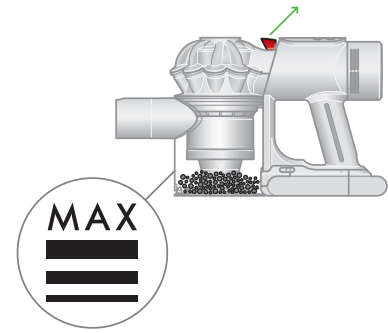

The MAX level mark can be seen on the side of your machine's bin.

Release the dirt

Remove the wand from your machine.

Hold your machine over a bin and pull the bin release catch upwards. The cyclone will slide up and the bin base will open.

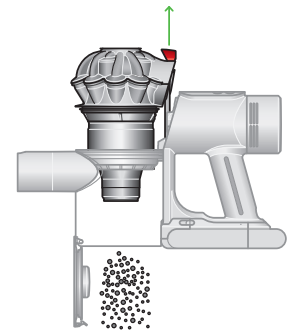

Minimize dust contact

Cover your bin tightly in a dust-proof bag while you empty. Remove the bin carefully, seal the bag tightly and dispose.

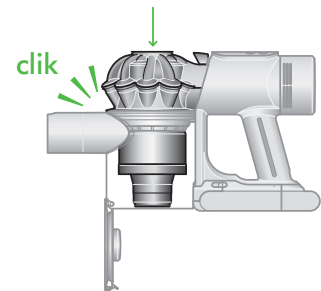

Close the bin

Push down on the cyclone until it slides into position. Push the bin base upwards until it closes securely.

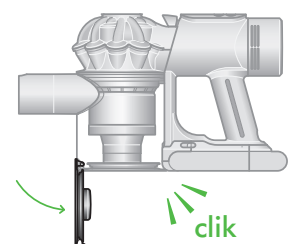

Cleaning the bin on your vacuum

Empty your bin as soon as the dirt reaches the top mark.

You may need to clean the filter more often if you use your machine with a full bin.

Empty your bin

Remove the wand from your machine.

Hold your machine over a bin and pull the bin release catch upwards. The cyclone will slide up and the bin base will open.

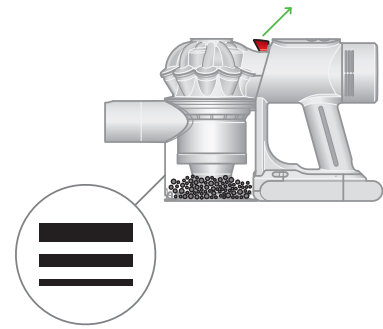

The MAX level mark can be seen on the side of your machine's bin.

Remove the cyclone

Pull the bin release catch upwards. The cyclone will slide up and the bin base will open.

Locate the cyclone release button behind the cyclone and push to remove the cyclone from your machine.

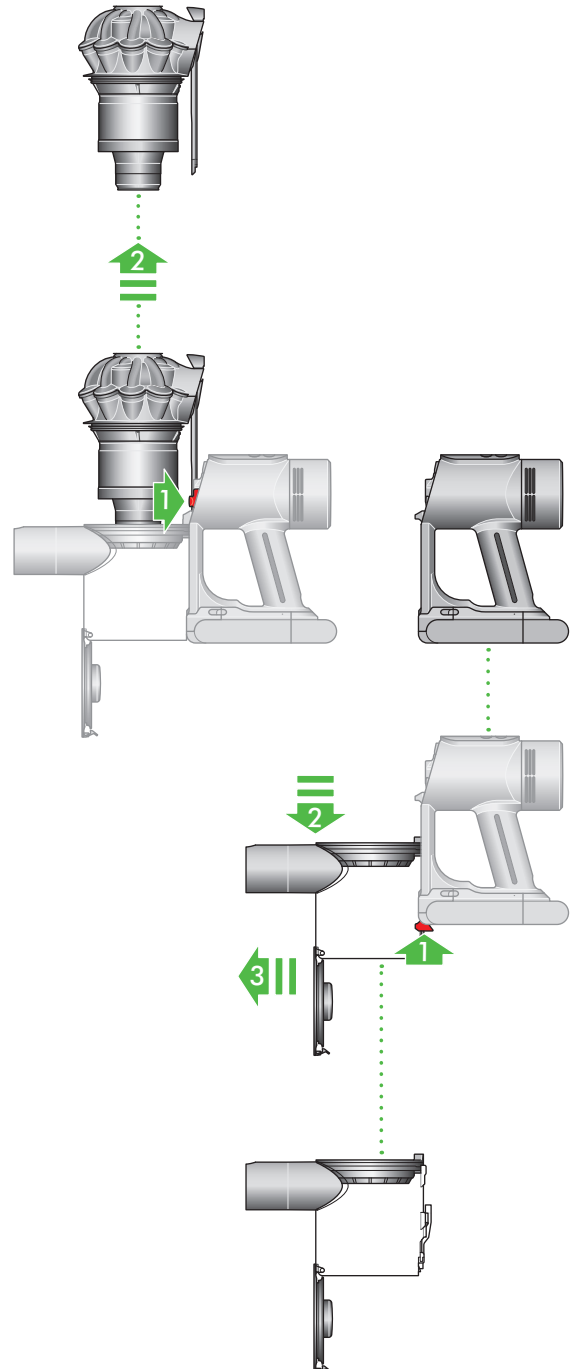

Remove the bin

Pull back on the red catch located on the base, slide the bin down and pull it off your machine.

Clean the bin

Wipe your bin with a damp, lint-free cloth. Don't put the bin in a dishwasher or use detergents, polishes or air fresheners.

Make sure the bin is completely dry before replacing.

Replace the bin

Align the tabs on the bin with the grooves on the main body and slide it upwards until it clicks into place.

Replace the cyclone

Slide the cyclone into the grooves of the main body and push down until it is in position.

Push the bin base up until it clicks firmly shut.

Clearing blockages from your vacuum

Your machine is fitted with an automatic cut-out. If any part of it is blocked, your machine's motor will pulse and won't function until the blockage has been cleared.

Disconnect your machine from the charger before looking for blockages. Be careful not to touch the trigger and be aware of sharp objects.

Leave your machine to cool down before looking for blockages.

Don't use your machine when looking for blockages as this could cause injury.

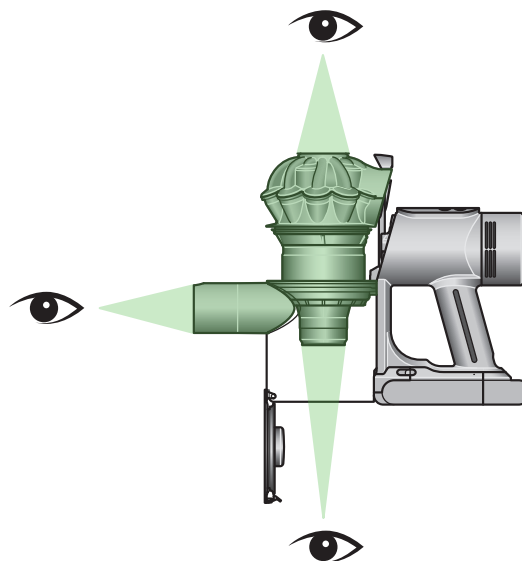

With the bin open, examine your vacuum for blockages. Pay particular attention in and around the cyclones and the tool/wand attachment point.

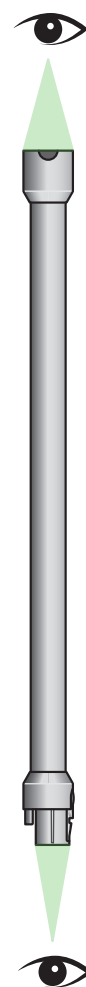

With the wand removed from the machine and cleaner head removed from the wand, check for blockages at both ends of the wand. Turn the cleaner head over to check for obstructions on the brush bar and air inlet. Remove any obstructions.

Washing the Pre-filter on your vacuum

Remove your filter

Lift the filter out of the top of the cyclone.

Tap to remove excess dust and debris.

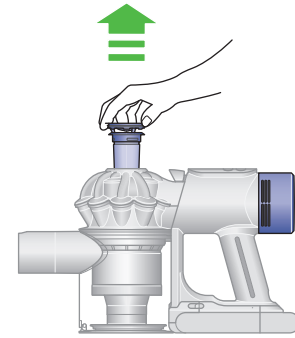

Wash your filter

Hold the open end of the filter under a running tap, until the water runs clear.

Turn the filter upside down and tap it to remove excess water.

Run water over the outside of the filter until the water runs clear.

Squeeze and twist with both hands to make sure the excess water is removed.

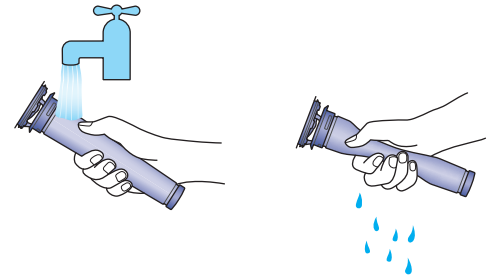

Dry your filter

Leave your filter to dry for at least 24 hours in a well-ventilated, warm place.

Do not dry your filter in a tumble-dryer or near a naked flame.

Important: Your filter must be completely dry before you put it back into the machine. Your machine could be damaged if used with a damp filter.

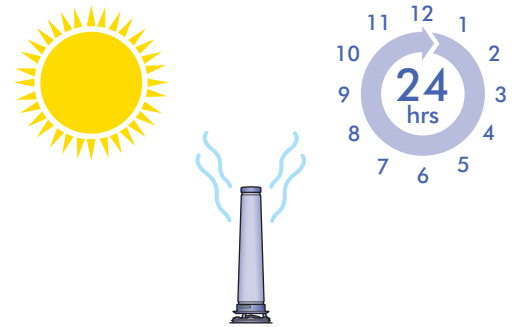

Caution: ensure your filter is fully dry before reinserting to the cyclone.

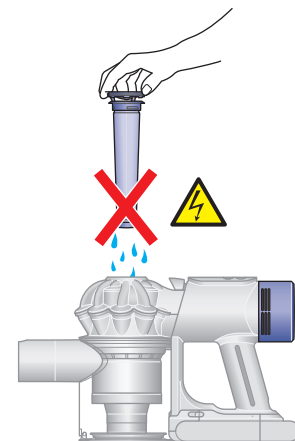

Refit your filter

Align the arrow on the top of the filter with the bin release button.

Push down to fit securely in place.

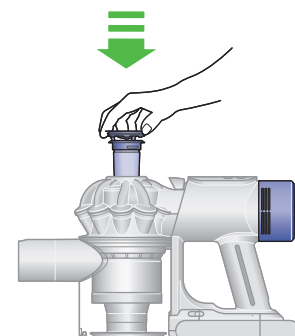

Washing the Post-filter on your vacuum

Twist off your filter

Twist your filter anti-clockwise and pull it away from your machine.

The Post-filter is removed from the back of the machine, above the handle.

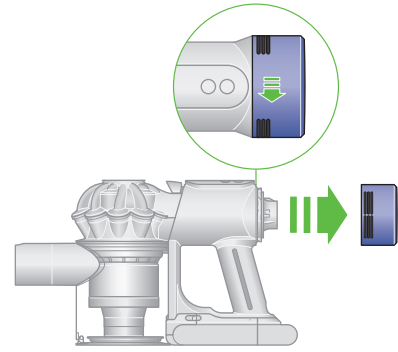

Wash your filter

Wash the inside of the filter under cold, running water, rotating the filter to make sure all of the inside is clean.

Repeat until the water runs clear.

Shake out the water

Empty the filter and shake firmly to remove excess water.

Keep shaking it until there's no water coming from the filter.

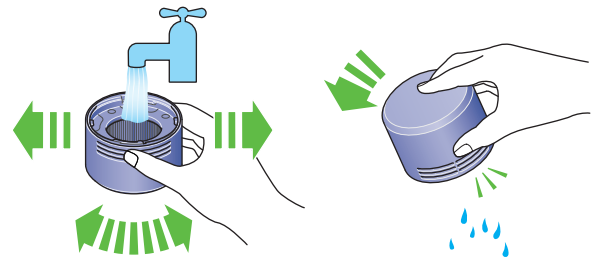

Dry your filter

Place your filter, with the open end facing up, to dry.

Leave your filter to dry for at least 24 hours in a well-ventilated, warm place.

Do not dry your filter in a tumble-dryer or near a naked flame.

Important: your filter must be completely dry before you put it back into the machine. Your machine could be damaged if used with a damp filter.

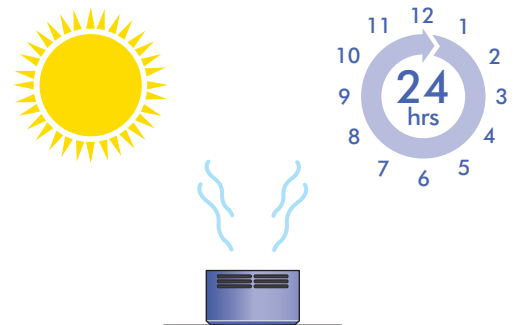

Caution: ensure your filter is fully dry before reinserting to the cyclone.

Replace your filter

Place your filter on your machine, aligned in the open position.

Twist clockwise until it clicks securely into position.

*Small details may vary

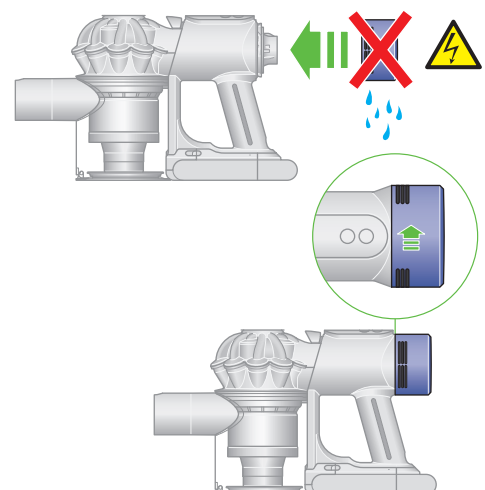

Clearing obstructions from your De-tangling conical head

Your De-tangling conical head doesn't have a washable brush bar. To maintain optimum performance, check your brush bars regularly and clear obstructions. Make sure your machine is disconnected from the charger and your machine power is turned off. Don't put any part of your machine in a dishwasher or use detergents, polishes or air fresheners.

Remove the cover and brush bars

Lift the plastic clips at the back of the cleaner head on the left and right to release the cover. Twist and pull each brush bar to remove.

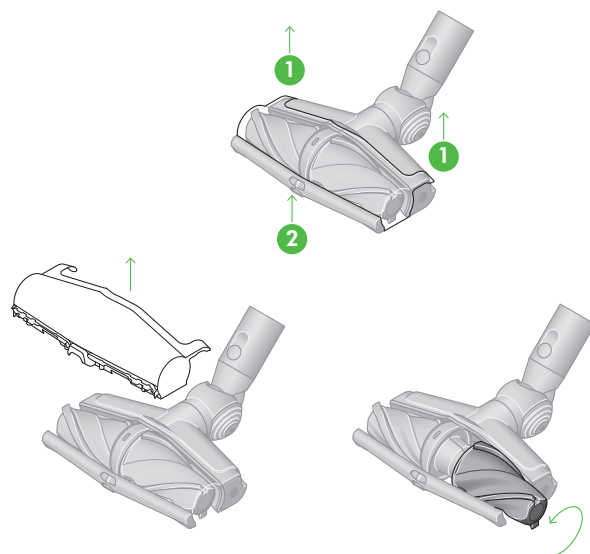

Look for obstructions

Clear any debris from your brush bar. Check inside the cleaner head and remove any debris or blockages. Your De-tangling conical head and brush bar aren't washable. Wipe over with a damp lint-free cloth.

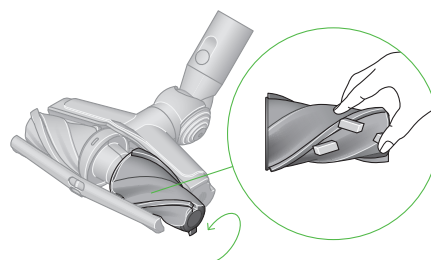

Re-assemble the De-tangling conical head

Reattach each brush bar by matching the colour of the plastic fitting on the cone to the same colour of the cleaner head. Refit the cover by gently slotting back into place and snap the clips back into place.

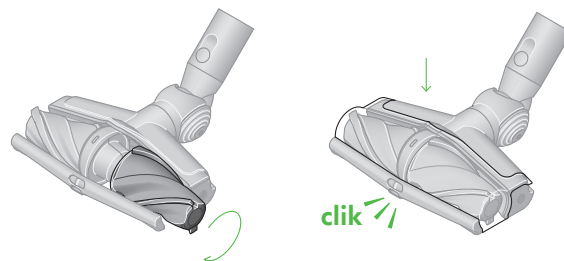

Clearing blockages from your Mini motorized tool

Your Mini motorized tool doesn't have a washable brush bar. To maintain optimum performance, check your brush bar regularly and clear any obstructions.

Make sure your machine is disconnected from the charger and take care not to touch the power button.

Remove your brush bar

Don't put any part of your machine in a dishwasher or use detergents, polishers or air fresheners.

Use a coin to unlock the end cap.

Twist the end cap and remove it from your brush bar. Don't wash the end cap.

Slide your brush bar out of the cleaner head.

Look for obstructions

Clear any debris from your brush bar.

Check inside the cleaner head and remove any debris or blockages.

Your Mini motorized tool and brush bar aren't washable. Wipe over with a damp lint-free cloth.

Replace your brush bar

Push the end cap back on to your brush bar and slide it back into the cleaner head.

Turn the end cap clockwise into the locked position.

Your cleaner head isn't washable and should only be wiped over with a damp lint-free cloth.

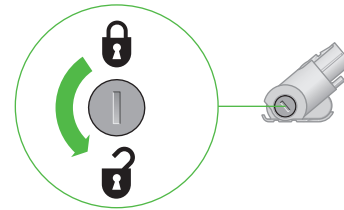

Twist the end cap anti-clockwise to remove it from the brush bar

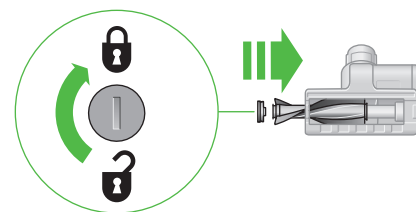
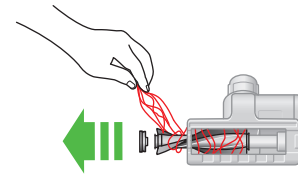

Cleaning your tools

Don't put any part of your machine in a dishwasher or use detergents, polishes or air fresheners.

Wipe with a damp, lint-free cloth, without touching the connector end.

Make sure your tools are completely dry before using.

Crevice tool

Do not wash any cleaner head or motorized tool. They contain electronic components that could be compromised by exposure to water, detergents, polishes or air fresheners.



Crevice tool

Do not wash any cleaner head or motorized tool. They contain electronic components that could be compromised by exposure to water, detergents, polishes or air fresheners.

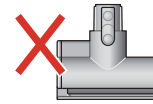

Mini motorized tool

Changing your Auto-empty Dok™ liner

Step 1

When the liner is full, the indicator light will turn solid orange when the machine is docked. The vacuum stops emptying immediately when the liner is full.

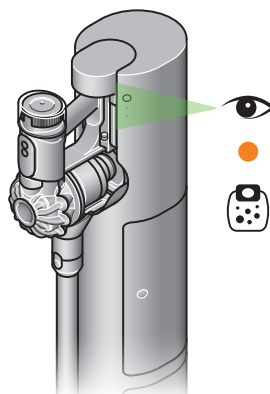

Step 2

Open the bottom door on the dock, and slide the full bin out of the dock. Dispose of the bin liner with all the dust into the trash.

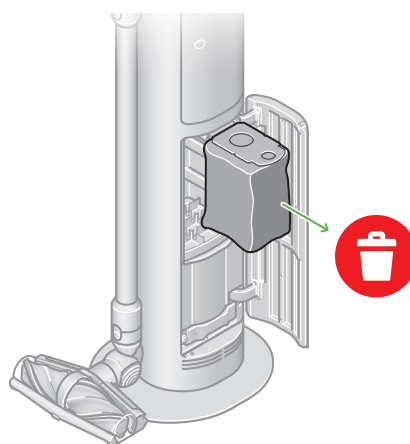

Step 3

Insert a new liner into the slot. To re-purchase bin liners, scan QR code below the bin.

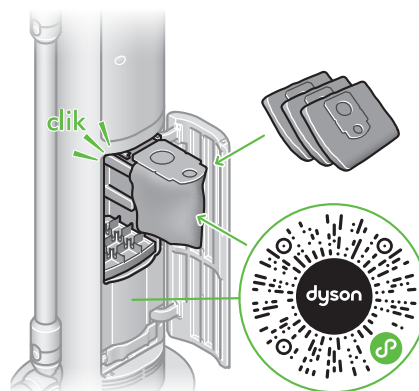

Step 4

Ensure the new liner is inserted correctly. If the indicator light does not turn off, re-insert.

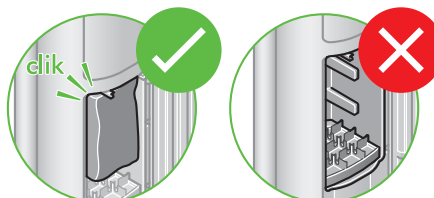
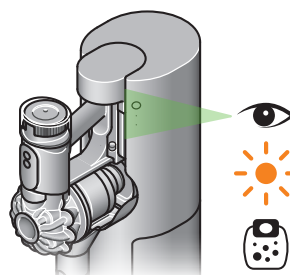

Washing the filter in your Auto-empty Dok™

For the best care and to maintain the dock performance, it is recommended to clean the dock filter every 2 months (60 days)

Pull and slide out the HEPA filter and run under tap water to clean it.

Shake and tilt it to ensure there is no excess water left in the filter.

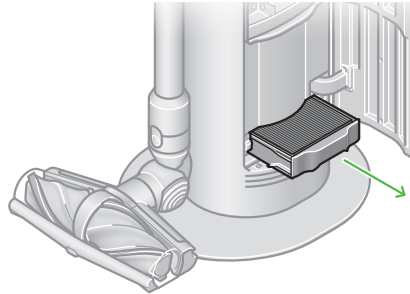

The filter is located at the base of your Auto-empty Dok and can be accessed with the bin door open.

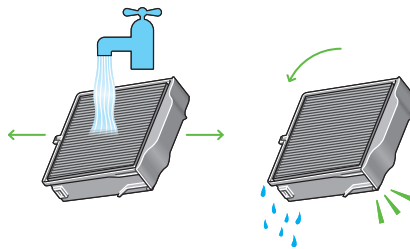

Ensure the filter is completely dry before inserting back into the dock.

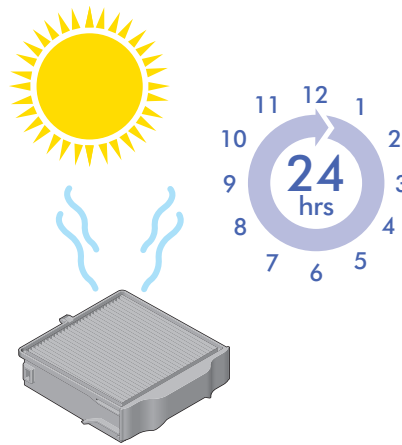

Allow 24 hours for filter to dry

Ensure the filter is inserted into the dock and the bottom door shut before starting self-emptying.

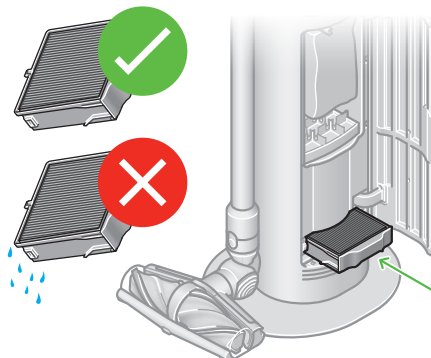

Re-purchasing dust liners for your Auto-empty Dok™

Replacement and spare dust liners can be purchased by:

- Visiting the Accessories page at www.dysoncanada.ca
- Using the MyDyson™ app
- Scanning the QR code on your dock

Looking after your machine

To always get the best performance from your machine, it's important to clean it regularly and check for blockages.

Day-to-day machine care

If your machine is dusty, wipe with a damp, lint-free cloth.

Look after your battery

For best performance and battery life, only use MAX mode when needed.

Your battery is designed to charge on the dock and stops charging when complete, so returning the machine to the dock after use helps to maintain battery life.

Your machine won't operate or charge if the ambient temperature is below 5°C (41°F). This is designed to protect both the motor and battery.

Where to find your machine's serial number

The serial number is printed on the main body of the machine, behind the back of the clear bin.

Use the serial number to register your machine.

For more information and support videos for your machine, go online: www.dysoncanada.ca/support