

# pencilvac

Dyson PencilVac Logo.

## User manual

SV12 JN.00000 PN.000000-00-00  
00.00.00 VERSION NO.01

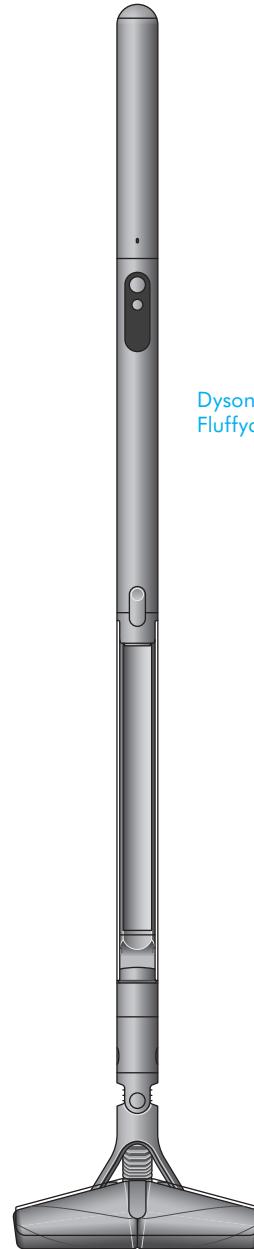

Dyson PencilVac cleaner with  
Fluffycones cleaner head

---

### Contents

In the box

Getting started

The LCD screen

Download the MyDyson™ app

Getting started on the MyDyson™ app

Emptying your bin

Cleaning your bin

Washing the Fluffycones™  
cleaner head

Washing the filter

Cleaning your tools

Clearing blockages

Clearing blockages from your

Hair screw tool

Disassembling your machine

Looking after your machine

**dyson** Dyson logo

# In the box

Your machine is boxed in 3 parts:

1. Machine body
2. Battery
3. Cleaner head/tools

Simply attach the battery to the main body and then the cleaner head/tool to the other end of the main body.



Illustrations of the Dyson PencilVac battery, machine body and cleaner head.

Battery



Machine body



Diagram of machine charger.

#### Charger

One-piece charger with plug, connector and cable. Charges your machine through the dock.

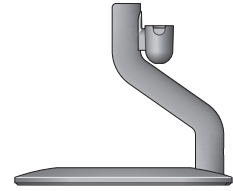
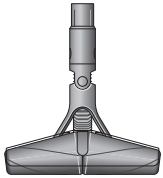

Diagram of charging dock.

#### Magnetic charging dock

Dyson PencilVac™ cleaner charges on the dock, ready for your next clean.



Fluffycones™ cleaner head

#### Our recommendation

Keep the charging jacks (on the charger and charging dock) away from conductive materials such as carbon fibre.

Disconnect the charger from the mains before cleaning.

Additional tools available.

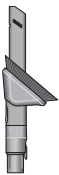

Rotating combi-crevice tool

# Getting started

## Get to know your machine controls



Diagram indicating mode, power and max buttons.

LCD screen

Mode select button

Power on/off button

## Before use

Charge on dock.

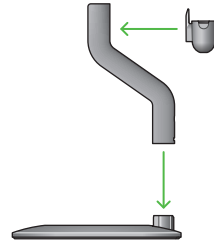

Diagram showing how the dock clicks together.

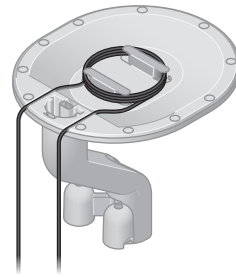

Diagram showing how to wind the cable around the base of the dock.



Diagram showing how the machine clicks together with green arrows.

↓ ≡ **clik**

## LCD screens showing each cleaning mode.

### Modes



#### Eco mode

Maximum run time for longer cleans all around your home.



#### Med mode

The optimum balance of power and run time. Attach your cleaner head or Hair screw tool to activate Auto mode. Suction power automatically adapts to dust levels.



#### Boost mode

Designed for intensive spot cleaning of ground-in dirt.



Diagram showing how to place the machine on the dock to charge.

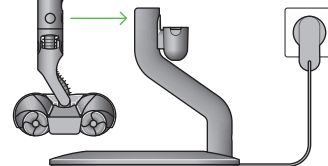

## Connect your machine

Using Bluetooth® wireless technology<sup>1</sup> or the QR code on the box or LCD on screen.



Illustration of a mobile phone with a Bluetooth icon



↓ ≡ **clik**

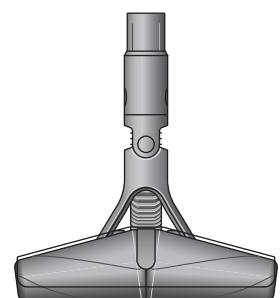

1. The Bluetooth® word mark and logos are registered trademarks owned by the Bluetooth SIG, Inc. and any use of such marks by Dyson is under license.

# The LCD screen

The LCD screen displays helpful performance information such as modes, remaining run time and essential maintenance alerts.

## Cleaning

Use the Mode button to select your power mode.  
Press start to begin cleaning.

### Eco

For fine dust.

Image of LCD screen showing 30 minutes run time in Eco mode.



### Medium

For normal levels of dust.

Image of the LCD screen showing 20 minutes run time in Medium mode.



### Boost

For larger volumes of dust and debris.

Image of the LCD screen showing 5 minutes run time in Boost mode.



## Alerts

The alerts you might see are:

Blockage – your machine has a blockage that needs removing.

Collection of images showing the alerts on your lcd screen when you have a blockage.

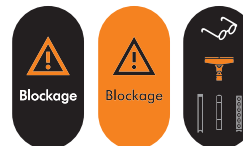

Filter – the filter isn't fitted correctly, or needs cleaning.

Collection of images showing the alerts on your lcd screen when you have a filter issue.



## Battery

When the battery is unable to function, you will be prompted with the alert.

Collection of images showing the alerts on your lcd screen when you have a battery issue.



## Runtime and battery

The LCD screen constantly displays the machine's remaining run time – so you'll always know how much cleaning time you have left.

Alert indicating low battery.

Your Dyson PencilVac™ cleaner runs on a click-in battery with up to 30 minutes of run time. To extend your cleaning time, you can order an extra click-in battery at [www.dyson.com](http://www.dyson.com)

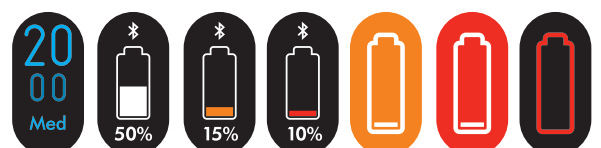

# Download the MyDyson™ app

Download the MyDyson™ app from the App Store or Google Play. Open the app and follow the on-screen instructions to create a new account.

Apple and the Apple logo are trademarks of Apple Inc., registered in the U.S. and other countries. App Store is a service mark of Apple Inc., registered in the U.S. and other countries. Google Play and the Google Play logo are trademarks of Google Inc.



Logos of Dyson, App store and Google Play.

---

## Getting started on the MyDyson™ app

### Connecting your machine

Scan the QR code on the LCD screen of your machine or find your machine through the MyDyson™ app.

Hold your mobile device next to your machine. Press the power button to activate pairing mode.

Once paired, follow the instructions within the app to set your language and activate your warranty. Setup is now complete.

Illustration of a hand holding a phone with the MyDyson app logo in the centre



# Emptying your bin

Empty your bin as soon as the dirt reaches the MAX mark. You may need to clean the filter more often if you use your machine with a full bin.

## Release the dirt

Press the red bin catch and pull the bin away from main body. Hold your vacuum over a bin. This action will move dirt from upper tray and separator. Repeat three times.

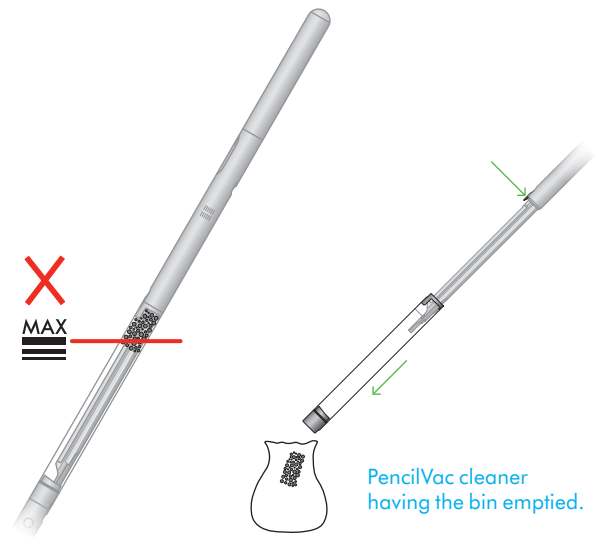

## Remove the bin

If the bin doesn't empty fully, remove bin and empty the dirt. Push the red bin stop catch on the separator to fully release the bin.

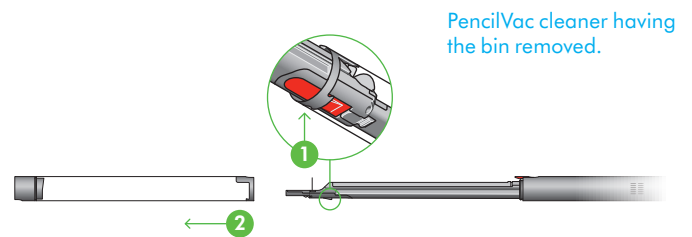

## Reassemble your machine

If you have removed your bin, slide it back on the separator. Make sure that the bin is fully secure until engaged by red bin catch.

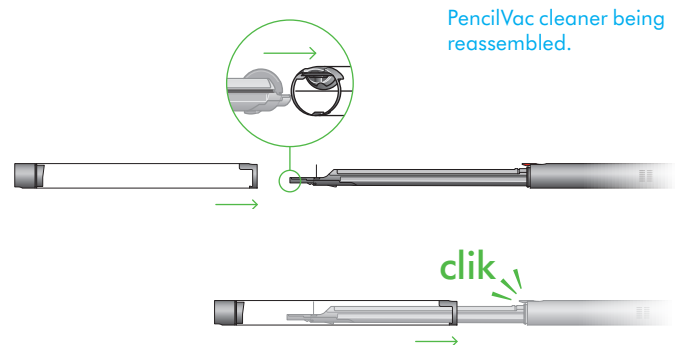

# Cleaning your bin

Don't put any part of your machine in a dishwasher or use detergents, polishes or air fresheners.

## Clean your bin

If it is necessary to clean your bin, empty it as shown in the 'Emptying your bin' section.

Press the red button located on the bin runner to release the bin and slide your bin off the runner.

Under flow of tap water, clean the dirt and rinse the bin.

Make sure that the bin and seals are completely dry before replacing.

## Replace your bin

Insert the spine on to the bin runner.

Close your bin by pushing the bin base upwards until the bin and bin base click into place.

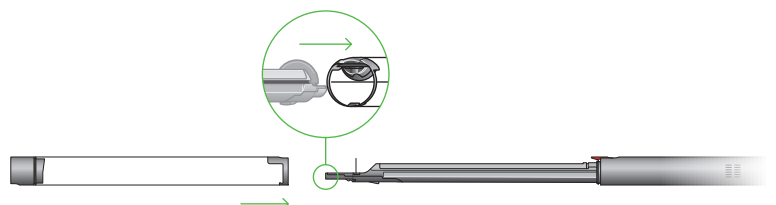

# Washing the Fluffycones™ cleaner head

## Remove the cones

Remove the upper plastic casing by gently lifting away from the cones. Unscrew each cone and pull away from fixture.

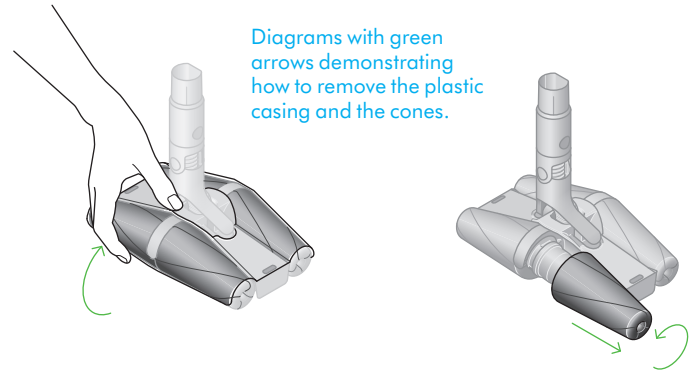

## Wash the cones

Wash the cones under running water. Squeeze to remove excess water and leave to dry fully.

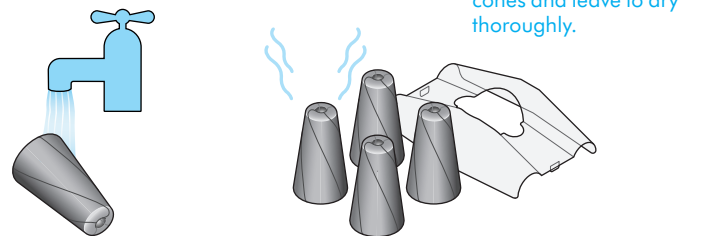

## Reattach the cones

Once dry, attach cones by matching the colour of the plastic fitting on the cone to the same colour on the cleaner head. Refit the upper plastic casing by gently pushing back into place.

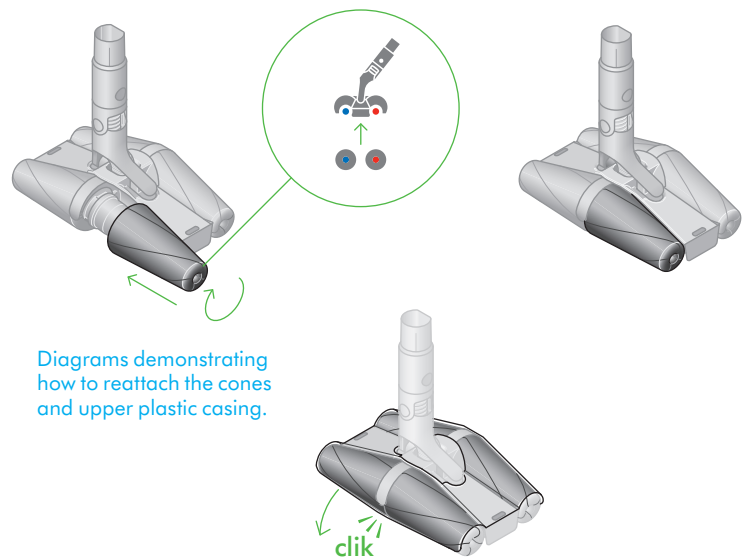

## Wipe charging contact

Ensure clean and fully dry.

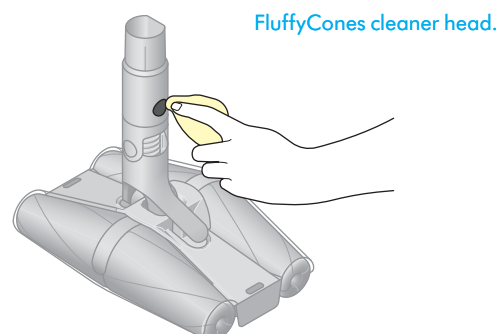

# Washing the filter

**Remove the cleaner head and extend the clear bin**  
Press the red release catch to remove the cleaner head.  
Press the red catch to fully extend the clear bin.

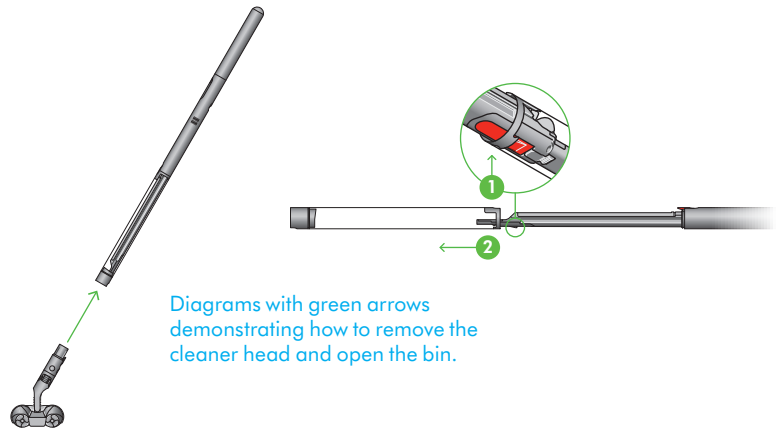

Diagrams with green arrows demonstrating how to remove the cleaner head and open the bin.

**Remove, empty and wash the filter**  
Squeeze and pull the red tab at the top to remove the filter from your machine. Slide down to separate the mesh from pleated filter.

Gently tap both the mesh and pleated filter into a bin to remove any excess dust and debris. Wash and vigorously shake both parts of the filter under running water.

Repeat the stages above until clear water passes through the pleated filter.

Shake to remove any excess water and leave for at least 24 hours to dry.

For quick regular cleaning of your filter, remove and gently tap away any excess dust or dirt. We recommend doing a full clean with water at least once a month.

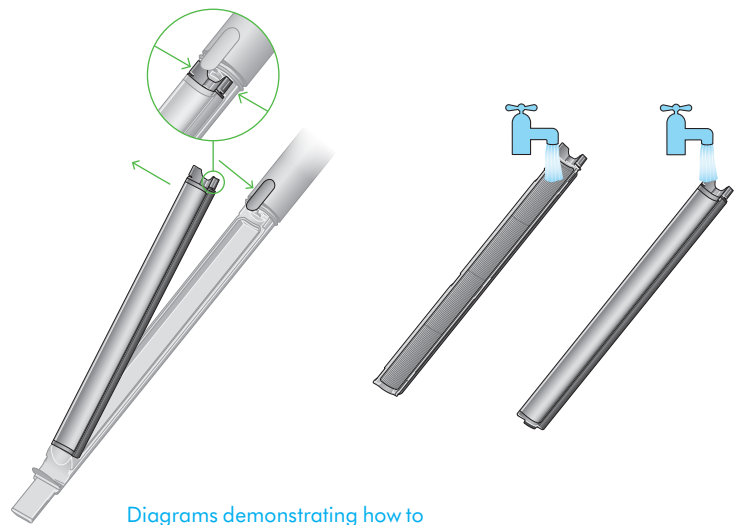

Diagrams demonstrating how to remove, tap and wash the filter.

**Refit the filter**  
Align and press side mesh to pleated filter. Align lower end filter and press to refit.

Reclose the clear bin and reattach cleaner head.

Three sequential diagrams demonstrating how to remove, tap and wash the filter.

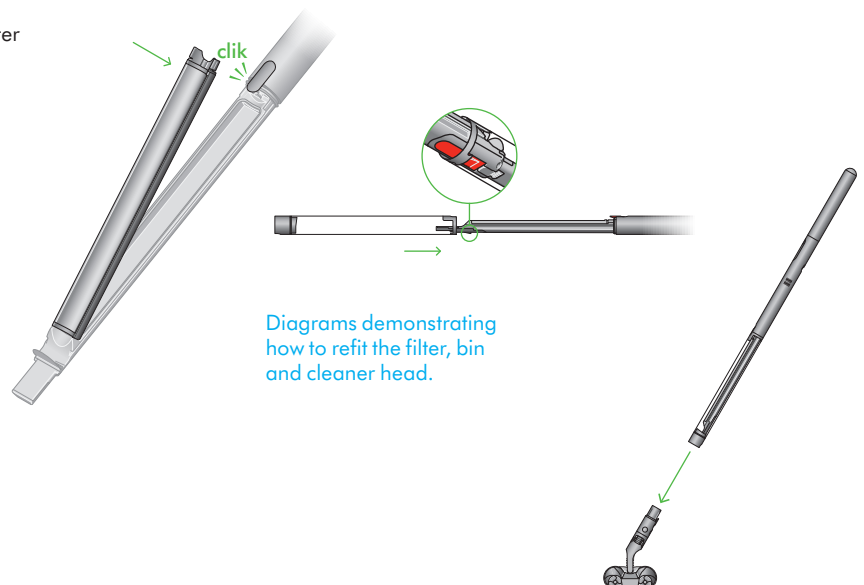

Diagrams demonstrating how to refit the filter, bin and cleaner head.

# Cleaning your tools

Don't put any part of your machine in a dishwasher or use detergents, polishes or air fresheners.

Wipe with a damp, lint-free cloth, without touching the connector end.

Make sure your tools are completely dry before using.

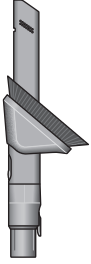

Rotating combi-crevice tool

# Clearing blockages

If your machine detects a blockage, an alert will show on the LCD screen. You won't be able to use your machine until the blockage has been cleared.

Leave your machine to cool down before looking for blockages and, for your safety, take care not to touch the power button.

Disconnect your machine from the charger before looking for blockages.

Leave your machine to cool down before looking for blockages.

Don't use your machine when looking for blockages as this could cause injury.

Be careful of sharp objects that may be blocking your machine.

Check for blockages in the cleaner head, and if needed, follow the instructions for removing the brush bars.

Make sure any blockages are completely cleared and all parts are fitted before using your machine.

Illustration showing to look for blockages in the cleaner head and bin.

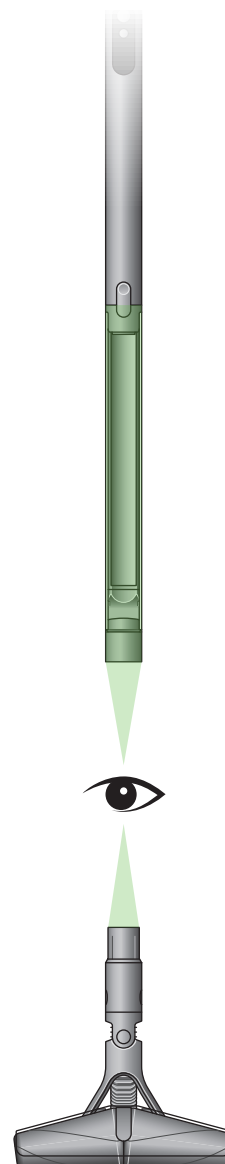

## Remove stuck hair or debris

Press the red button to remove the baffle and remove the obstruction. Once cleared, refit the baffle.

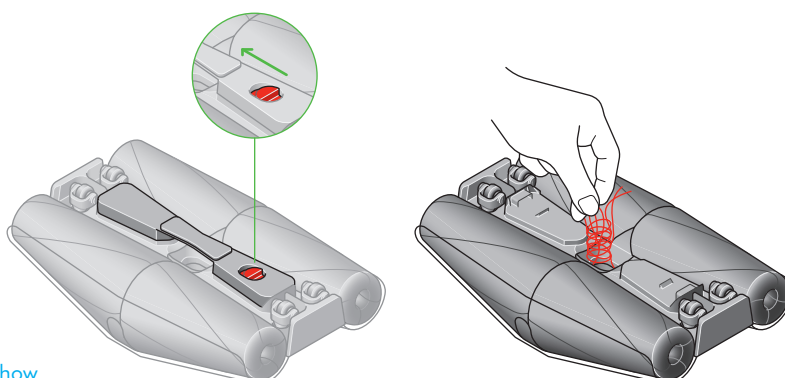

Illustrations to show the baffle being removed and the obstruction taken out of the cleaner head.

# Disassembling your machine

Should you need to store or repackage your machine, detach the cleaner head and battery from the main body, as shown opposite.

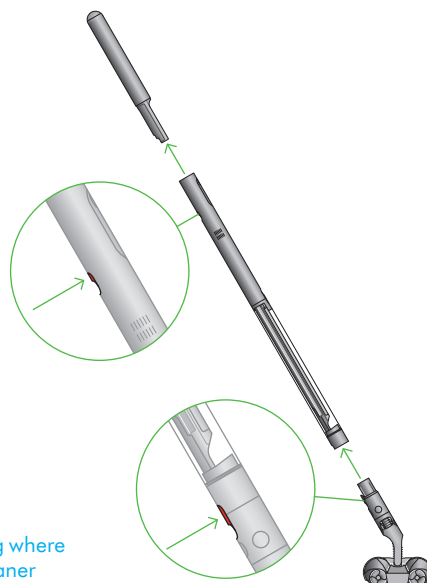

Diagram indicating where to separate the cleaner head and the battery.

Detach the stem from the base of the dock by pressing both catches inward and pulling the stem away from the base.

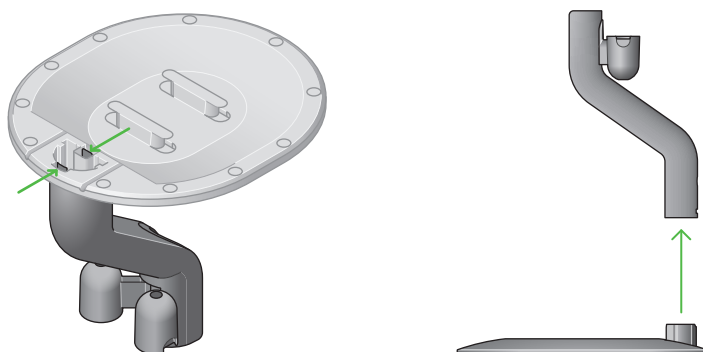

Diagram showing that the dock comes apart by pinching together the clip.

# Looking after your machine

## Day-to-day machine care

To get the best performance from your machine, it's important to clean it regularly.

If your machine is dusty, wipe with a damp lint-free cloth.

## Battery health

For best performance and battery life, use Boost mode only for an intense burst of power.

Your battery is designed to charge on the dock and stops charging when complete, so return the machine to the dock after use, helps maintain battery life.

## Where to find your machine's serial number

The serial number is printed on the main body of the machine, behind the back of the clear bin.

Use the serial number to register your machine.

For more information and support videos for your machine, go online: [www.dyson.com/support](http://www.dyson.com/support)